



CENTURY
P O O L S
Q U E E N S L A N D

Century Pools Queensland

Stunning Fibreglass Pools

For South East Queensland Homes

About Century Pools



Century Pools has been established as the market leader in the supply of fibreglass pools in Australia. Our traditional business model is based on customer service and using Australian made products, that grant our customers an exceptional pool experience.

Our Vision

Our Vision is to provide quality services that exceeds the expectations of our customers.

Our Purpose

To be the leader in the pool industry by providing innovative products, and a passion for customer satisfaction above all.

Our Mission

To build long term relationships with our customers and clients and provide exceptional customer services by pursuing business through innovation and advanced technology.

OUR WARRANTY IS CLEAR,
COMPREHENSIVE AND DESIGNED
FOR YOUR PEACE OF MIND.

Century Pools warrants to all of its valued customers that every pool:

01

Has been manufactured under strict quality assurance controls and exceeds Australian and World standards for strength and durability

02

Has a unique registration number for product process control and traceability, recording material weights, wall thickness, hardness, production environment.



03

Only the best materials, operating conditions and production crews are used to build our pools. You are getting the benefit of manufacturing and support from people with extensive skill and knowledge in the swimming pool manufacturing industry.

04

Century Pools carries our providers to the highest of standards within regards to Warranty. Our Century Range has a 30 Year Structural Warranty, with a Lifetime Colour Shield Warranty. Our Freedom Range has a Lifetime Structural Warranty.

24 YEARS
IN THE MAKING



**Century
Range**



Diamond Series

The ultimate large family pool with an innovative design featuring great entrance points at both ends of the pool, plus a large ledge spanning the length of the pool that offers easy access, safety and the perfect spot for relaxation and socialising

11m Diamond Pool

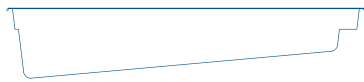
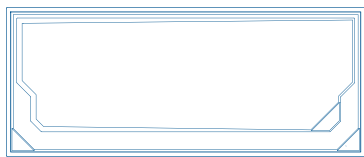

2.1m 1.2m

10m Diamond Pool

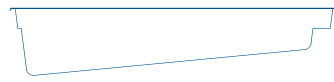
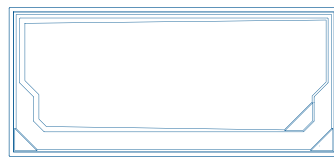

2.01m 1.2m

8m Diamond Pool

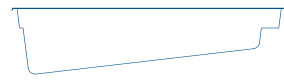
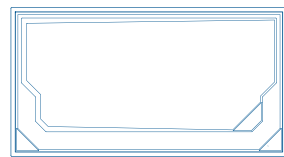

1.87m 1.2m

7m Diamond Pool

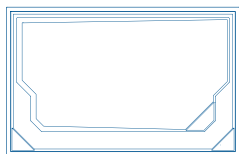

1.76m 1.2m

6m Diamond Pool

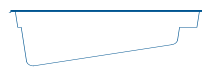
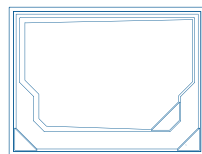

1.65m 1.2m



Sapphire Series

A beautiful family pool with a unique design featuring entrance points at both ends of the pool, inset corners, plus a large ledge spanning the length of the pool that offers easy access, safety and the perfect spot for relaxation and socialising

11m Sapphire Pool

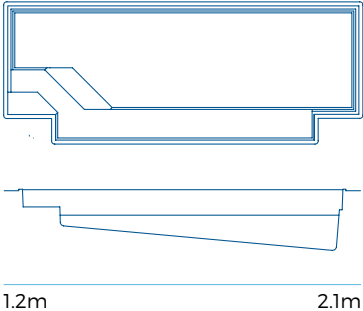

10m Sapphire Pool

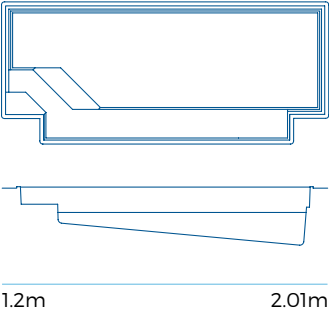

8m Sapphire Pool

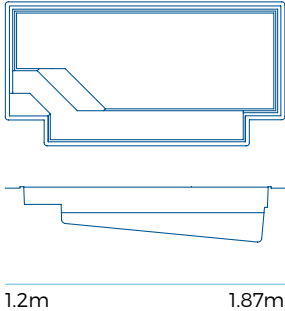

7m Sapphire Pool

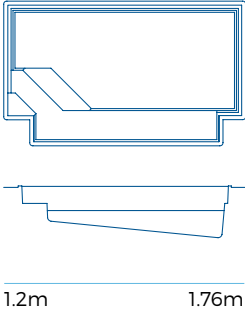

6m Sapphire Pool

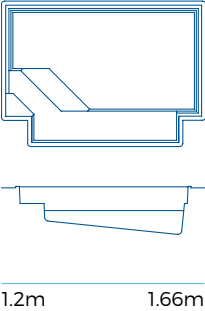



Emerald Series

A sleek family pool with a user friendly design featuring an entrance point at one end of the pool, inset corners, plus a large ledge spanning the length of the pool that offers easy access, safety and the perfect spot for relaxation and socialising

8.4m Emerald Pool

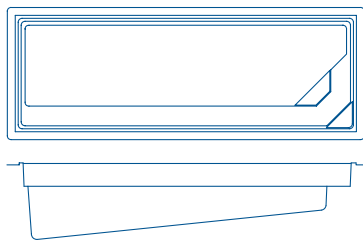

1.95m 1.2m

7.2m Emerald Pool

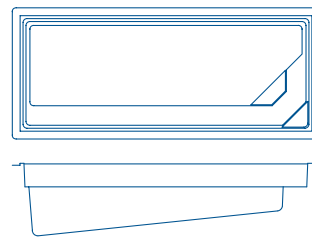

1.83m 1.2m

6m Emerald Pool

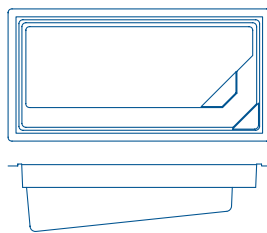

1.71m 1.2m

5.2m Emerald Pool

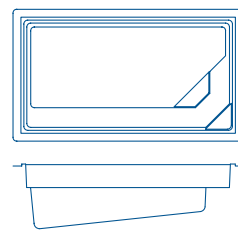

1.63m 1.2m



Finishes Reference Guide

Diamond & Sapphire Series Pool Colours



Century Blue

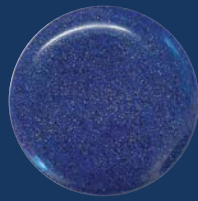

Regal Blue

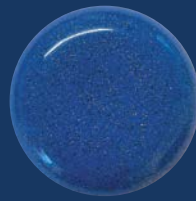

Marine Blue

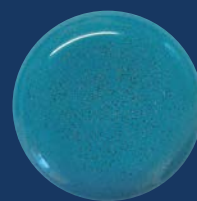

Aqua Mist

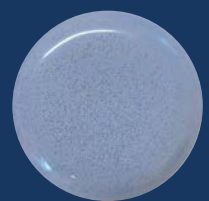

Blue Mist

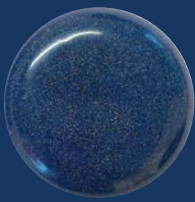

Imperial Shimmer



Teal Shimmer

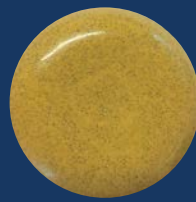

Sunrise Shimmer

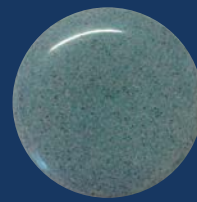

Mystic Grey

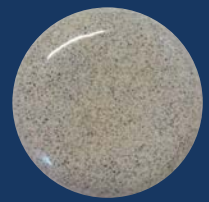

Century Silver



Grey Mist



White Glaze

Please note that due to inconsistencies of various monitors, printers, digital photography and variances during manufacturing processes, colours and images used in this document should be considered as a guide only.



CHLORSHIELD is supplied by the leading manufacturer RF Composites, and is the world's leading gelcoat technology. CHLORSHIELD is designed to and delivers the ultimate in durability and unparalleled protection for your swimming pool against bleaching and chemical attack. Never before seen performance that not only easily surpasses Australian Standard AS1838:2021, but blows it out of the water and is offered in an extraordinarily wide range of vivid colours and highlights. It also boasts 99.5% gloss retention, outstanding UV protection and incredible flexural strength.

30 YEARS
Structural Warranty

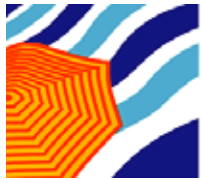

HARVEST
POOLS



Caesar Range

The Caesar swimming pool is elegant and functional with entry steps on the shallow end and spacious seating on the deep end. There is a safety foot ledge running along each side of the pool so you can rest assured swimmers of all ages can stay safe and make the most of their time in or by the pool.



	Length	Width	Depth
External	11.7m	4.25m	0.95m-1.78m



	Length	Width	Depth
External	9.7m	4.25m	0.95m-1.53m



	Length	Width	Depth
External	7.7m	4.25m	0.95m-1.35m



Classic Range

The practical and attractive design of the Classic swimming pool is popular amongst homeowners, because it is the design most people think of when they decide to install an indoor pool on their property. Make summer days longer, more refreshing and luxurious, with our Classic fibreglass pool and enjoy all the benefits it brings. The Classic swimming pool design features entry steps at the shallow end as well as a seat on each side of the deep end. A safety foot ledge for comfort and security frames the periphery of the swimming pool. The border or ledge of the swimming pool can be customised to suit your exterior design.



10m CLASSIC



	Length	Width	Depth
External	10.1m	4.4m	0.95m-1.78m



8m CLASSIC

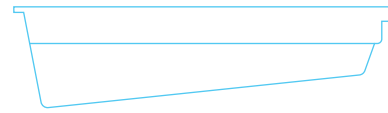

	Length	Width	Depth
External	8.0m	4.4m	0.95m-1.59m



Harvest Range

The Harvest swimming pool has a 'right-side' design that looks sleek and stylish in any backyard. The entry steps are located on the right side near the shallow end, while the left side of the pool has generous seating from the shallow to the deep end. The Harvest pool design is a great choice if you're looking at new lap pools, or if you just want a spacious swimming pool for entertaining and family fun.



	Length	Width	Depth
External	11.4m	4.4m	1.09m-1.85m



	Length	Width	Depth
External	10.4m	4.4m	1.07m-1.78m

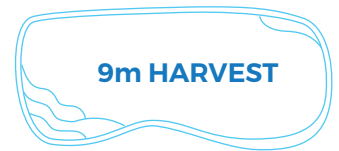

	Length	Width	Depth
External	9.4m	4.4m	1.05m-1.7m



	Length	Width	Depth
External	8.4m	4.4m	1.05m-1.63m



	Length	Width	Depth
External	7.4m	3.87m	1.09m-1.55m

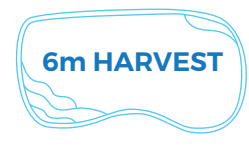

	Length	Width	Depth
External	6.4m	3.87m	1.09m-1.48m



Lap Pool Range

Our fibreglass lap pools are high quality, durable and low maintenance, boasting a stunning appearance for years. Installation is easy, with the shell delivered directly to your property. Once installed, your lap pool won't ever need to be repainted or resurfaced. Our fibreglass lap pools are available in multiple colours, from classic shades of blues to sand and white marble.



15m LAP POOL

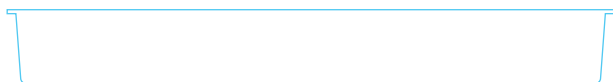

	Length	Width	Depth
External	15.0m	3.0m	1.3m



12m LAP POOL

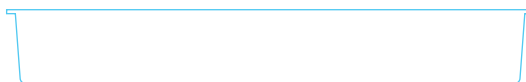

	Length	Width	Depth
External	12.0m	3.0m	1.3m



Swim Spa Range

Our beautiful range of fibreglass pools offers the perfect balance for those who want to enjoy ultimate relaxation in heated pools or a swim spa but have limited space in their backyard. Our two-in-one swim spa design combines a swim current with a luxurious hydro massage. This means that our gorgeous spa pools help you transform your NSW home into an oasis, all year round.

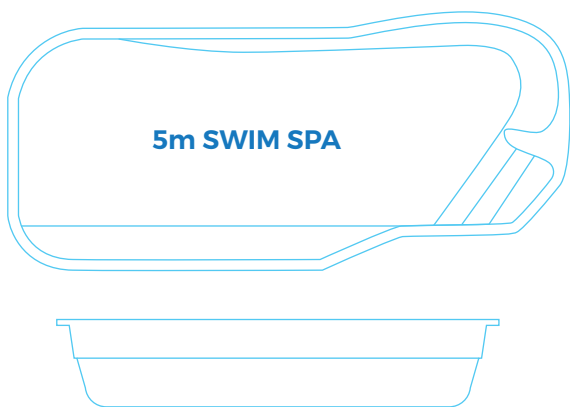

	Length	Width	Depth
External	5.5m	2.6m	1.2m



	Length	Width	Depth
External	4.9m	3.2m	1.25m



Oz Pool Range

The Oz is a luxury pool design that features a left-side entry, with entry steps and seating on the left side of the shallow end. There is also extra seating located on the left side, at the deep end of the swimming pool. A safety foot ledge is also included with the Oz, for security and improved pool design. The Oz focuses on optimising swimming space and is sure to match the aesthetics of any well-designed garden landscaping and home exterior.



9m OZ POOL

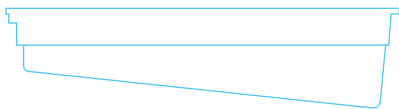

	Length	Width	Depth
External	9.2m	4.4m	1.11m-1.72m



8m OZ POOL

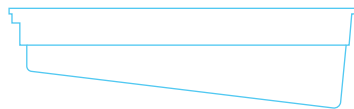

	Length	Width	Depth
External	8.2m	4.4m	1.11m-1.63m



7m OZ POOL

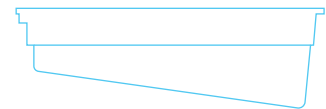

	Length	Width	Depth
External	7.2m	4.4m	1.17m-1.63m



In-Ground Spa Range

Our in-ground spa pools come in two varieties. The first is a square shape 2.1 metres by 2.1 metres with a depth of 0.9 metres. The second is a round shape that is 2.6 metres by 2.3 metres with a depth of 0.92 metres. You can select the one that best fits the dimensions of your yard or your aesthetic preferences.

2m IN-GROUND SPA

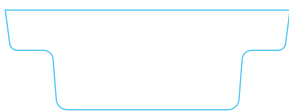
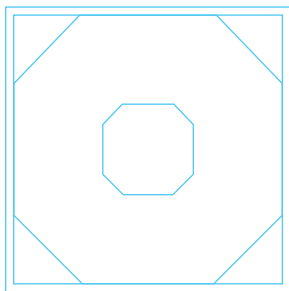

	Length	Width	Depth
External	2.1m	2.1m	0.56m-0.9m

2m IN-GROUND SPA

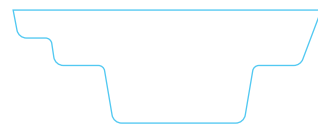
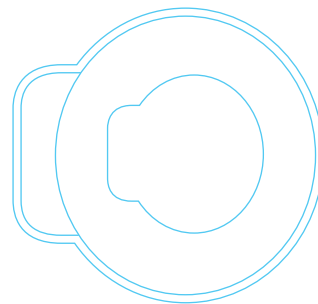

	Length	Width	Depth
External	2.6m	2.3m	0.58m-0.92m



Waterhole Range

Waterhole design is 2.5 metres wide and comes in three lengths: 4.36, 5.36, and 6.36 metres. Even if you have a relatively small courtyard or garden, we'd love to take a look, so that together we can explore the possibilities for installing a compact, contemporary Waterhole pool.

We have Standard, Cultured, and Starlight colours to choose from so you can look forward to a Waterhole pool that suits your style preferences. From rich blues to light sandy shades, we have something for everyone.

6m WATERHOLE

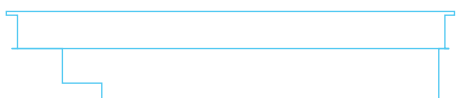
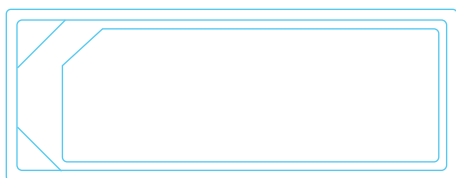

	Length	Width	Depth
External	6.36m	2.5m	0.61m-1.5m

5m WATERHOLE

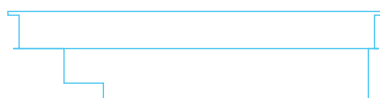
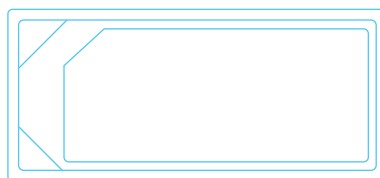

	Length	Width	Depth
External	5.36m	2.5m	0.61m-1.5m

4m WATERHOLE

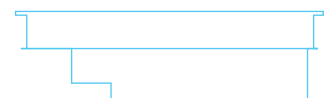
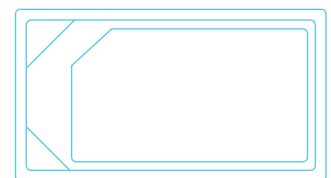

	Length	Width	Depth
External	4.36m	2.5m	0.61m-1.5m



Urban Pool Range

If a practical family pool is on your wish list, this Urban pool is perfect for your garden. Take your pick of three Urban pool sizes: 8 x 3 metres, 7 x 3 metres, or 5.8 x 3 metres.

There's also no shortage of eye-catching colours to choose from. Our impressive colour range includes Standard, Cultured, and Starlight finishes to make your new pool shine. Whether you want a deep Bermuda blue or a crisp Grey Granite, we've got you covered.



8m URBAN



	Length	Width	Depth
External	8.0m	3.0m	1.3m-1.72m



7m URBAN



	Length	Width	Depth
External	7.0m	3.0m	1.3m-1.67m



5m URBAN



	Length	Width	Depth
External	5.8m	3.0m	1.31m-1.6m



Venice Range

Be the first to own the new ultra-modern Venice pool design from Harvest Pools, the leading pool suppliers in NSW. With a unique shape that will fit a variety of backyard areas and compliment any modern home, this family-friendly design offers an extra safety ledge, dynamic stair design and a swim out. Shop contemporary inground pools and lap pools with us today and make your summer superior.

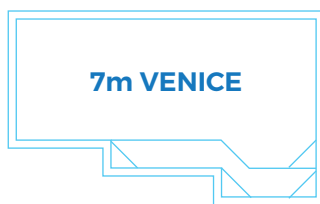

7m VENICE



	Length	Width	Depth
External	7.0m	4.26m	1.21m-1.62m

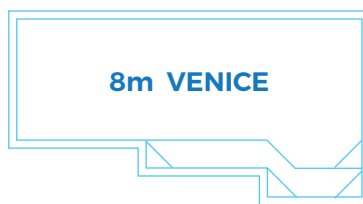

8m VENICE



	Length	Width	Depth
External	8.0m	4.26m	1.18m-1.66m

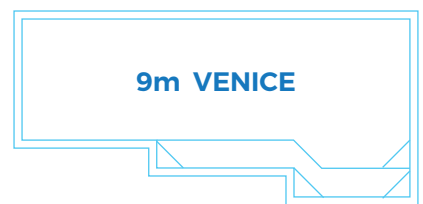

9m VENICE



	Length	Width	Depth
External	9.0m	4.26m	1.14m-1.69m



Retreat Range

The Retreat pool range is currently available in 5 metre, 6 metre, 7 metre, 8 metre, 11 metre, and 12 metre lengths. We can survey your property to help you decide on the right size for plunge pools.

Don't forget to check out our amazing array of pool colours for an outdoor or indoor swimming pool. Not only do you deserve a relaxing new pool, but also a beautiful style that reflects your favourite colours. White Marble, Aqua Jade, and Blue Grey are a few of the fabulous options that look great in Standard, Cultured, or Starlight finishes.



	Length	Width	Depth
External	12.0m	4.2m	1.06m-1.88m



Finishes Reference Guide

Colour Range



Aqua Jade



Bermuda Blue



Blue Grey Starlight



Coral Blue



Daintree Starlight



Grey Granite



Ivory Sand



Lagoon



Mid Blue



Pebble Starlight



Sapphire Starlight



White





Quality Certified Pool Construction

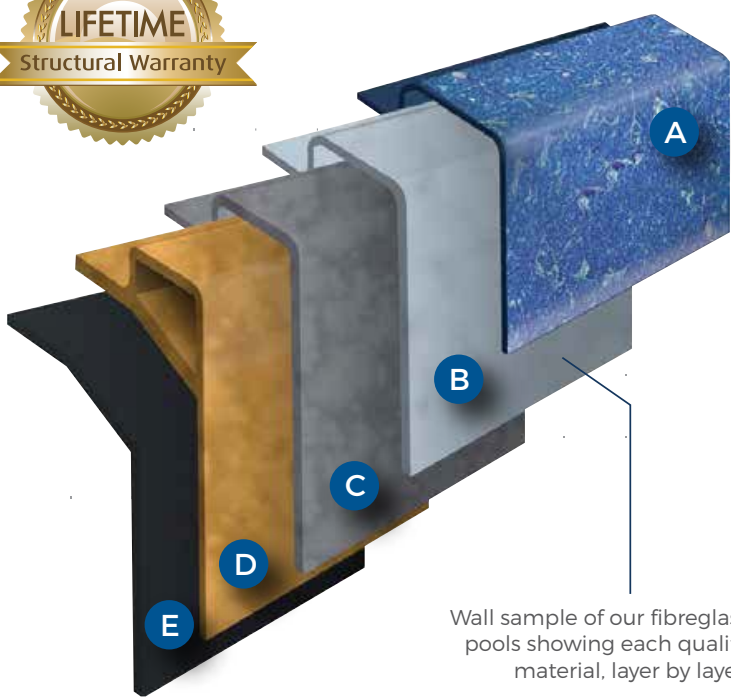

Wall sample of our fibreglass pools showing each quality material, layer by layer.

- A** Chemical resistant and U.V. stabilised MarbleTech gelcoat.
- B** Epoxy based vinyl ester resin impervious to water and provides better chemical protection.
- C** Two structural layers of clear fibreglass lamination applied to the required structural thickness.
- D** Close-beam construction means your pool is built using the strongest method of construction available in the industry.
- E** Special black flowcoat seals the outside of the pool against any exposed fibres.

! The above certified construction method is approved by **Lloyd's of London** for the construction of boats and fibreglass swimming pools.

Freedom Pools *Shell* CONSTRUCTION ADVANTAGES

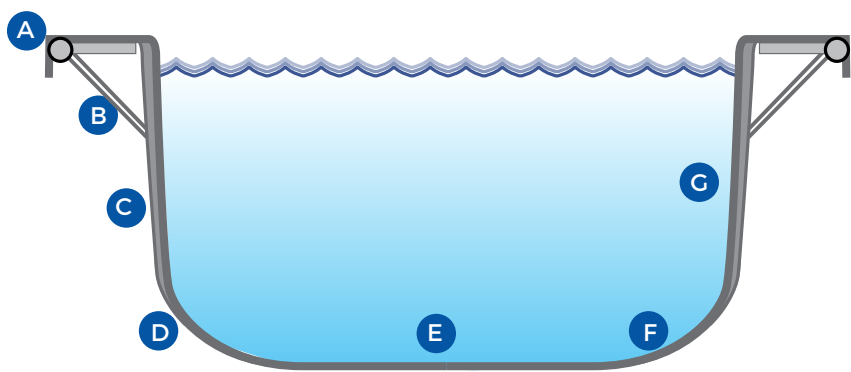

- A** Outer edge beam
- B** Angle brace
- C** Fibreglass wall supports
- D** Flowcoat to outer structure
- E** Non slip surface
- F** Large radius designed for auto cleaner
- G** Inner wall

NEW GENERATION Freedom Pools STRONGER BY DESIGN



Over time, we have consistently developed and improved existing design principles and applied them to our pool models. Freedom Pools always provide a high quality and durable solution for your pool requirements.

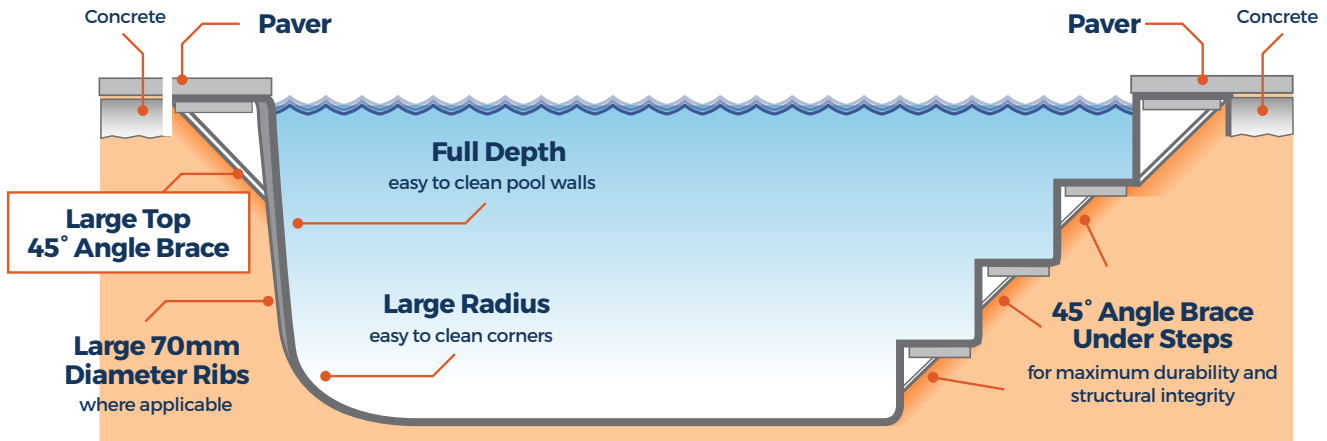

INVEST IN THE BEST,
WHEN ONLY THE BEST WILL DO!

AUSTRALIA ISO
QUALITY STANDARD
CERTIFIED



Tried and tested engineering standards and installation techniques have been refined over many years to give you total peace of mind when you choose a

Freedom Pool





Lap Pools

The classic Lap Pool offers the perfect balance between family fun and a serious training. This well designed and sophisticated pool features entry and exit steps that are out of the way of the swim zone. A built in ceramic tile racing line at the bottom of the pool makes this the perfect pool for individuals who like to workout. The Lap Pool's narrow design is well placed with today's narrow lot homes.

8m Lap Pool

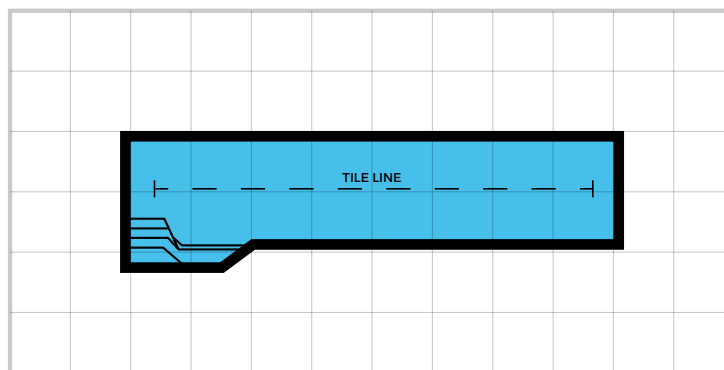

LENGTH: 8.0m WIDTH: 2.0m DEPTH: 1.4m

11m Lap Pool

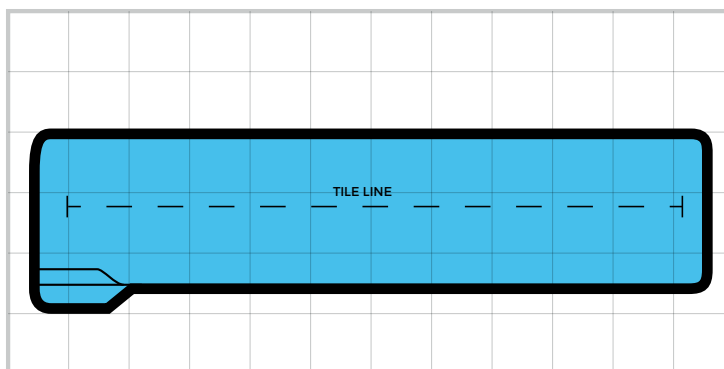

LENGTH: 11.0m WIDTH: 2.4m DEPTH: 1.4m



Champagne Range

The Champagne has been crafted for families with young children. The dynamic pool design features a large relaxing lounge with table for entertaining and a moulded reclining bed with optional air blower. Entry steps left and right of the shallow end provides additional seating for relaxing and socialising. The opposite end of the pool is deep enough for older children and adults to swim freely

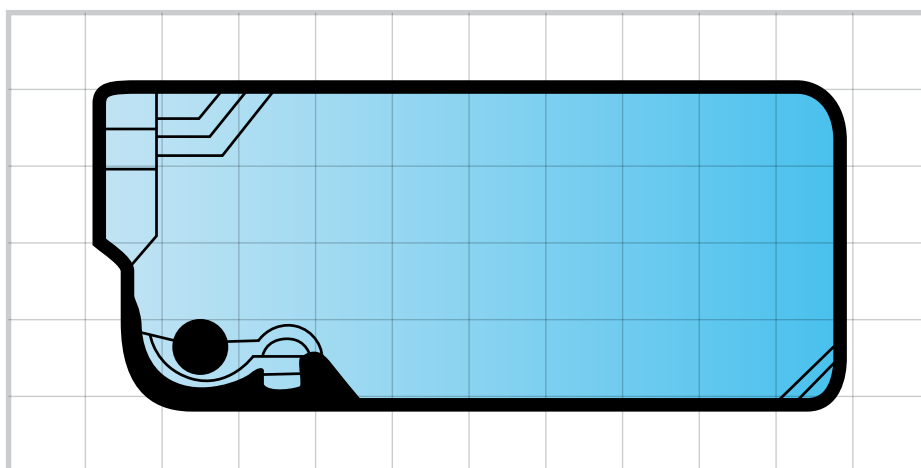

LENGTH: 9.4m WIDTH: 3.9m DEPTH: 1.1m -2.0m



Freedom Range

The Freedom Range of freeform pools is perfect for young families. The design features safety ledges and handgrips around the perimeter of the pool making it well suited for children learning to swim. The ledges also offer a place for swimmers to sit and relax, and provide convenient entry and exit from the pool. To create the ultimate pool for entertaining, enhance the seating and table area with spa jets and air blowers

Freedom 7

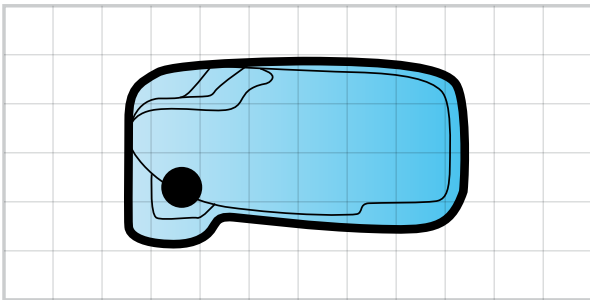

LENGTH: 6.7m WIDTH: 3.55m DEPTH: 1.1m -1.5m

Freedom 8

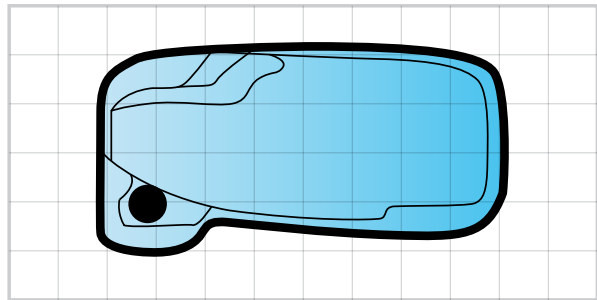

LENGTH: 8.1m WIDTH: 4.0m DEPTH: 1.1m -1.7m

Freedom 9

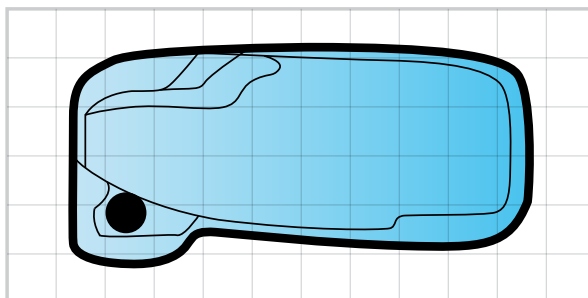

LENGTH: 9.1m WIDTH: 4.25m DEPTH: 1.1m -1.8m



Beach Pool Range

The Beach Pool is a new patented design from Freedom Pools, it is a sleek rectangular pool designed to fit seamlessly into any modern backyard. Ideal for children to play in safely this pool is the ultimate entertainer for weekends with friends or family. No need to drive to the beach ever again when you have the Beach Pool in your own back yard. This pool is family friendly for those with children. Add a sense of elegance and indulgence with the addition of a stylish water feature sold separately

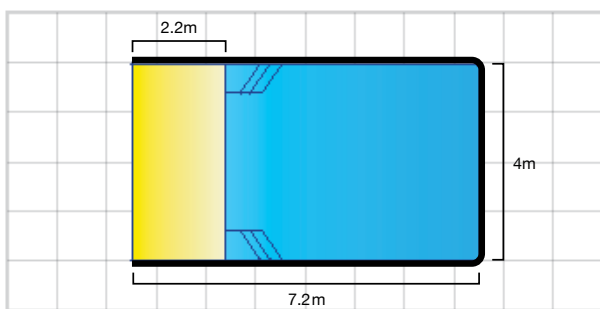

LENGTH: 7.2m WIDTH: 4m DEPTH: 0.00m - 1.4m x 1.8m

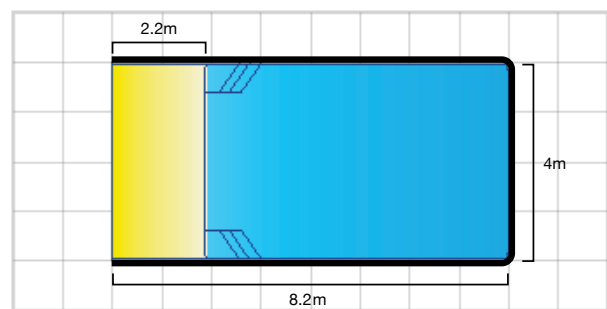

LENGTH: 8.2m WIDTH: 4m DEPTH: 0.00m - 1.4m x 1.9m

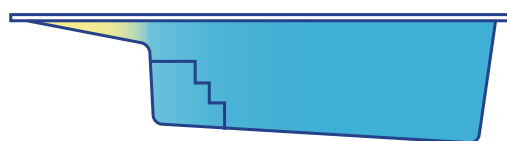

Side Elevation



Corinthian Range

The Corinthian is Freedom Pools most elegant pool. The discerning design takes inspiration from traditional Greek architecture and is the perfect addition to a modern family home. Grand entry steps located at the shallow end of the pool can be used as seating when entertaining. The deep end includes a ledge that can be used as seating on hot summer days. The Corinthian has a vast amount of room for swimming making it the perfect pool for large parties. Optional spa jets can also be added to this swimming pool.

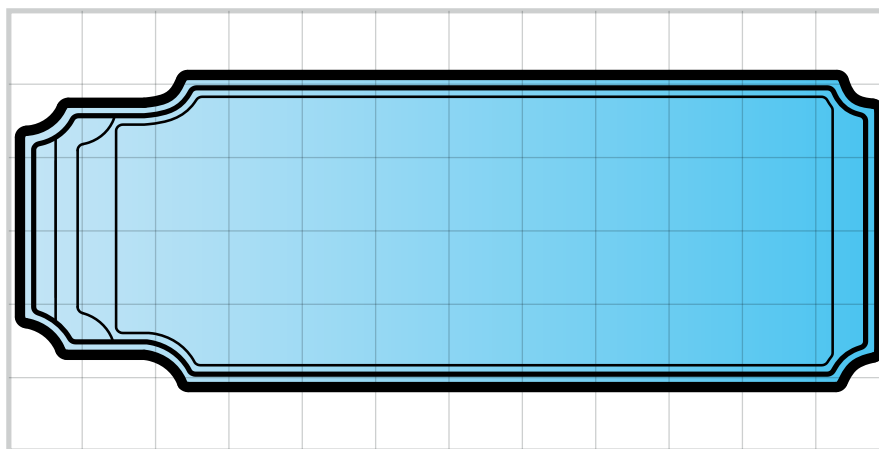

LENGTH: 11.6m WIDTH: 4.1m DEPTH: 1.1m -2.0m



Clip on Spas

The 6 person Clip On Spa can be added to any of our pools or installed as a stand-alone addition to your backyard. Massaging foot and back jets, and separate heating controls ensures that your spa will always be comfortable and relaxing. The Clip On Spa has been carefully designed to fit seamlessly with its surroundings. Customise your stand-alone spa with our range of waterline tiles or add a crafted spillway feature to upgrade your pool and spa combo.

Clip On Spa 2.4m

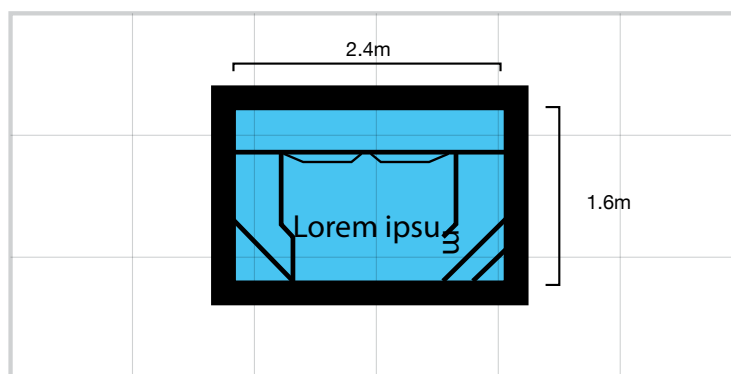

LENGTH: 2.4m WIDTH: 1.6m DEPTH: 0.9m



Finishes Reference Guide

MarbleTech™ FX Range

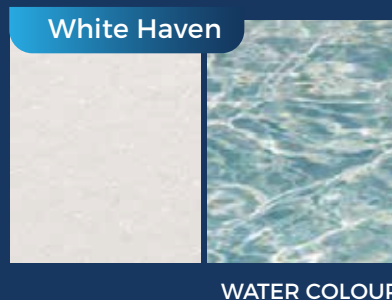
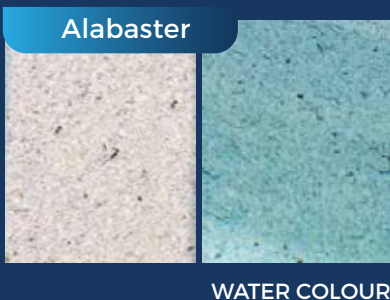
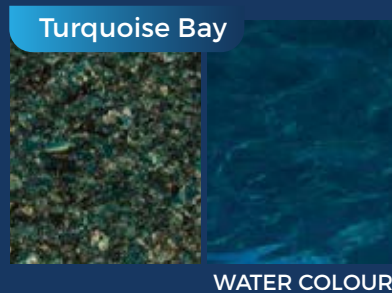
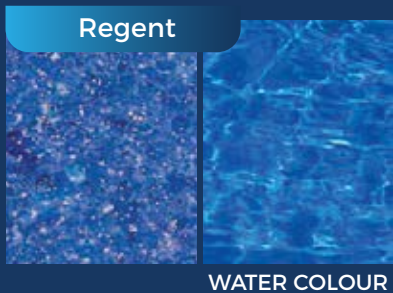
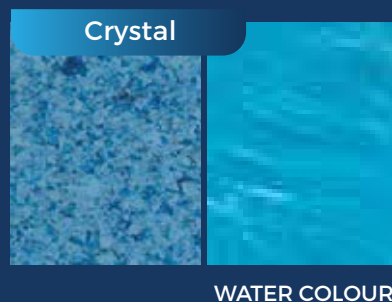
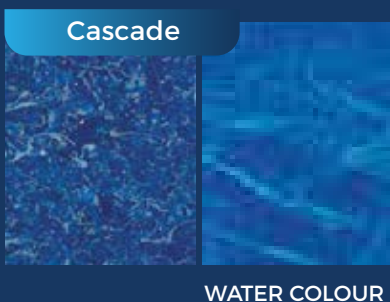
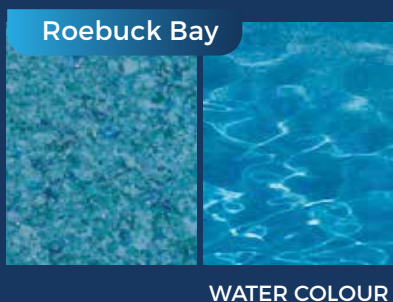

Shimmer Range

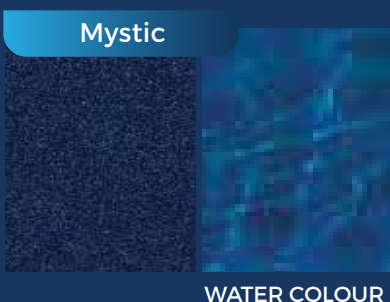

EXCLUSIVE TO FREEDOM POOLS

MarbleTech™



WATER COLOUR

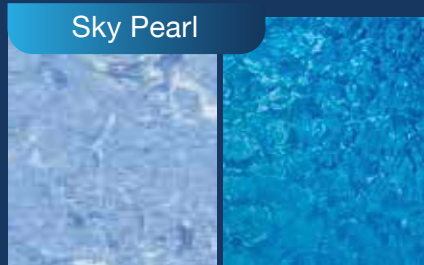

WATER COLOUR

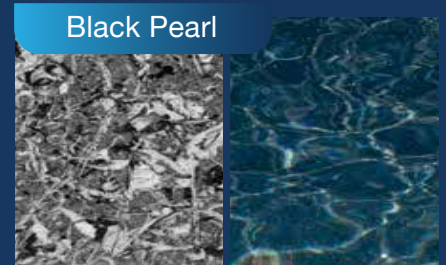

WATER COLOUR

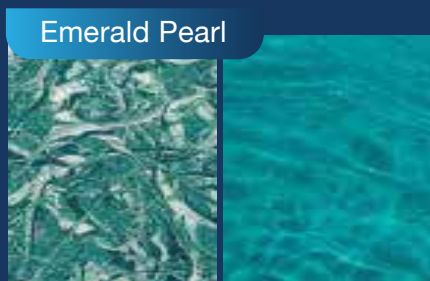

WATER COLOUR

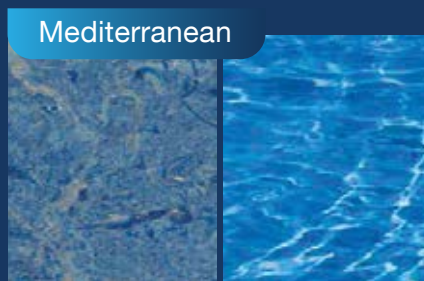

WATER COLOUR

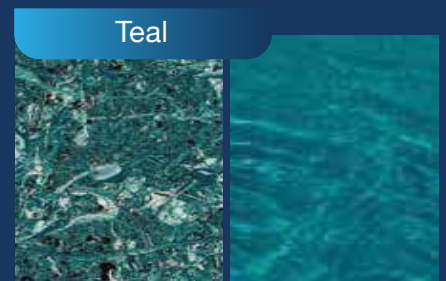

WATER COLOUR



WATER COLOUR



WATER COLOUR



WATER COLOUR

Shimmer Range

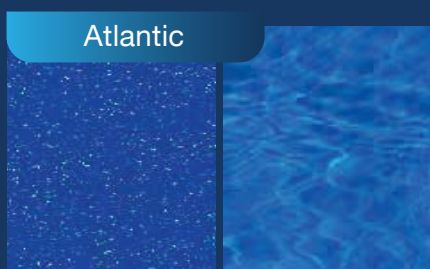

WATER COLOUR



WATER COLOUR





CENTURY
P O O L S
—
Q U E E N S L A N D

1300 440 891
3775 Pacific Hwy, Loganholme
Tanah Merah 4129

CENTURYPOLS.COM.AU